

Overall dimensions

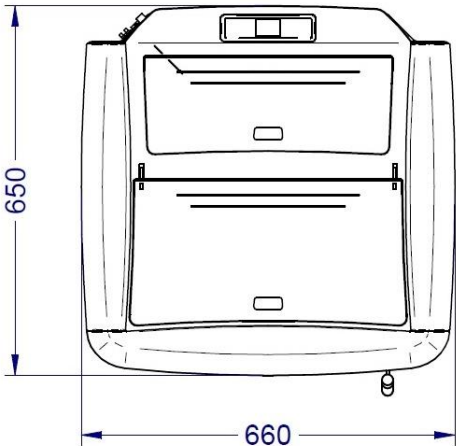

Connections data sheet

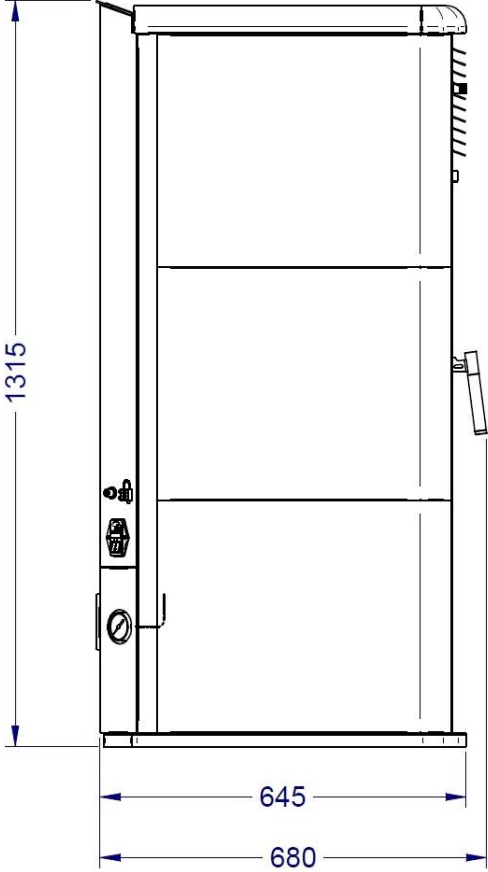
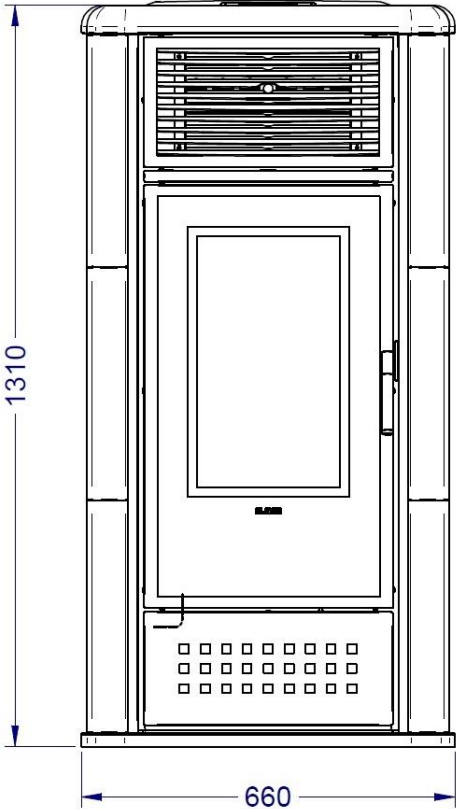
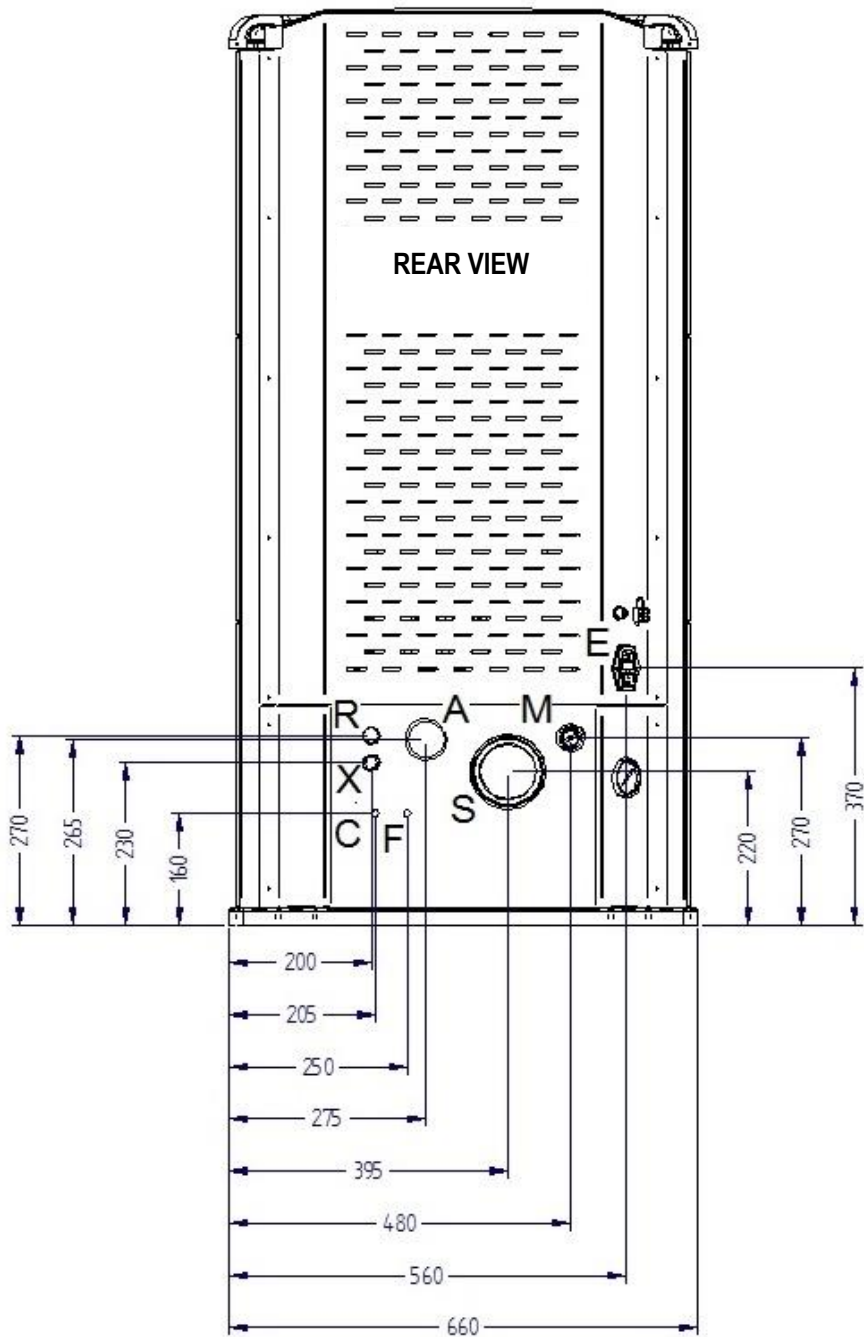

Description of connections	
M = System Delivery	3/4" F
R = System Return	3/4" M
F = Domestic cold water inlet (on prepared models only)	1/2" M
C = Domestic hot water outlet (on prepared models only)	1/2" M
X = Safety valve drain	1/2" F
A = Intake pipe	60 mm
S = Flue gas outlet	100 mm M
E = Electricity connection	